

# 2020 TECHNICAL REGULATIONS

Revision Date: December 20, 2019



Series:

**IMSA WEATHERTECH SPORTSCAR CHAMPIONSHIP**

Class:

**LE MANS PROTOTYPE 2**



Sanctioned by:

**INTERNATIONAL  
MOTOR SPORTS  
ASSOCIATION**

One Daytona Blvd.  
Daytona Beach, FL 32114  
(O) +1 (386) 310-6500  
(F) +1 (386) 310-6695  
[www.imsa.com](http://www.imsa.com)

## Table of Contents

<b>Foreword:</b>	<b>3</b>		
<b>ARTICLE 1. DEFINITIONS SPECIFIC TO THE TECHNICAL REGULATIONS</b>	<b>5</b>		
<b>ARTICLE 2. TECHNICAL PHILOSOPHY</b>	<b>6</b>		
2.1. Technical Eligibility	6		
2.2. Balance of Performance Adjustment	6		
2.3. Changes	6		
<b>ARTICLE 3. USING THESE TECHNICAL REGULATIONS</b>	<b>6</b>		
3.1. Structure	6		
3.2. Conflict Resolution	7		
3.3. Final Authority	7		
<b>ARTICLE 4. HOMOLOGATION</b>	<b>7</b>		
4.1. Homologation Regulations	7		
4.2. Homologation Process	7		
4.3. Homologation Files and Documentation	7		
4.4. Homologation Inspection	8		
4.5. Homologation Testing	8		
4.6. Homologation Identifier	8		
4.7. Conditions for Use of a Specific Homologation	8		
<b>ARTICLE 5. TECHNICAL ELIGIBILITY</b>	<b>9</b>		
5.1. Technical Credential Process	9		
5.2. Technical Credential Files and Documentation	9		
5.3. Technical Eligibility Testing	9		
5.4. Technical Credential Identifier	10		
5.5. Conditions for Use of Specific Technical Credential	10		
<b>ARTICLE 6. BALANCE OF PERFORMANCE</b>	<b>10</b>		
6.1. Balance of Performance	10		
6.2. Criteria for Adjustments	10		
6.3. Adjustment Parameters	10		
6.4. Release of Adjustments	10		
<b>ARTICLE 7. SAFETY</b>	<b>10</b>		
7.1. Driver Safety Harness System	10		
7.2. Seat	11		
7.3. Driver Containment Nets	11		
7.4. Protective Padding	11		
7.5. Protective Shielding	11		
7.6. Master Electrical Switches	11		
7.7. Fire Suppression System	12		
<b>ARTICLE 8. DEFINITION OF CLASS</b>	<b>13</b>		
8.1. Le Mans Prototype 2 (LMP2)	13		
<b>ARTICLE 9. VEHICLE SYSTEMS</b>	<b>13</b>		
9.1. General	13		
9.2. Modifications to the Specification	13		
9.3. Servicing, Repair, and Replacement	13		
9.4. Dimensions	14		
9.5. Chassis	14		
9.6. Driver Interface	14		
9.7. Bodywork	15		
9.8. Aerodynamic Elements	15		
9.9. Engine System	16		
9.10. Boost Management	16		
9.11. Drive System	16		
9.12. Cooling System	17		
9.13. Fuel System	17		
9.14. Brake System	17		
9.15. Steering System	18		
9.16. Suspension System	18		
9.17. Wheels & Tires	18		
9.18. Electronics	19		
<b>ARTICLE 10. SERIES REQUIRED ELECTRONICS</b>	<b>19</b>		
10.1. Series Scrutineering Data System	19		
10.2. Safety Light System	20		
10.3. Driver ID System	21		
10.4. X2 Transponder System	21		
10.5. Leader Light System	22		
10.6. Back-lit Panel	22		
10.7. Pro-Am Light	22		
10.8. Rain Light	22		
10.9. In-Car Camera	22		
<b>ARTICLE 11. REFUELING SYSTEM</b>	<b>23</b>		
11.1. Fuel Transfer	23		
11.2. Pit Tank	23		
11.3. Peripheral Connections	23		
11.4. Refueling/Vent Hoses	24		
11.5. Pit Tank Support Stand	25		
11.6. Boom	25		
11.7. Refueling Restrictor	26		
11.8. Level Sensor System	26		

## Foreword:

For all Members, the IMSA RULES of the International Motor Sports Association establish the foundation for the organization and conduct of all IMSA Sanctioned Events. The IMSA RULES take effect immediately upon publication.

The purpose of the RULES is to: (i) promote safety, the sport of automobile Competition and IMSA, (ii) enhance Competition, (iii) ensure the quality, fairness and integrity of the IMSA programs and operations and (iv) achieve prompt finality in the Competition results (“**Purpose**”).

### **ALL MEMBERS ARE REQUIRED TO REVIEW THESE IMSA RULES CAREFULLY.**

The **IMSA RULES** consist of following three (3) sections and the Event Supplementary Regulations (**SR**):

- The Technical Regulations, which outline the rules and regulations for the specific cars and equipment. The Technical Regulations may be modified or changed at any time by the publication of a Technical Bulletin, amending the Technical Regulations.
- The IMSA Sporting Regulations (**ISR**), which concern Competitor and Event procedures, as well as guidelines for the safe and uniform operation of the sport. The ISR may be modified or changed at any time by the publication of a Competition Bulletin, amending the ISR.
- The Series Supplementary Regulations (**SSR**) that provides Series-specific information about each IMSA Series. The SSR is integrated into the ISR and are designated with “(SSR)” next to the Paragraph title. The SSR may be modified or changed at any time by the publication of a Competition Bulletin, amending the SSR.

Any portion of the RULES may be modified through Bulletins (Competition Bulletins and Technical Bulletins, respectively) and takes force when published. Once published, the Bulletin shall take precedence over the applicable portion of the RULES. Additionally, the RULES may be modified for an Event by the Race Director through the mandatory briefing instructions.

### **HOW TO READ THE RULES**

- 1) These Technical Regulations are a Permissive document. Unless specifically defined as permitted, any modification, change, or adjustment is inherently prohibited. This philosophy is more clearly defined in Article 4 and specific modifications are clearly defined in Article 9.
- 2) The Technical Regulations are specific to particular categories, classes and types of race cars in a Series. Where the Technical Regulations conflict with the ISR or the SSR, the Technical Regulations shall govern.
- 3) The SR is specific to an Event and published in conjunction with the Event schedule. Where SR conflicts with the ISR, SSR, and/or Technical Regulations, the SR shall govern.

**EXECUTIVE LEADERSHIP MASTHEAD**

**John Bishop\* / Bill France, Sr.\***

**Founders – IMSA**

**Dr. Don Panoz\***

**Legacy Vice Chairman**

**Jim France**

**Chairman**

**Lesa Kennedy**

**Director**

**Ed Bennett**

**Chief Executive Officer**

**John Doonan**

**President**

**Tracey Lesetar-Smith**

**Director and Legal Counsel**

**Simon Hodgson**

**Vice President, Competition**

**David Pettit**

**Vice President, Marketing**

**\*Deceased**

## ARTICLE 1. DEFINITIONS SPECIFIC TO THE TECHNICAL REGULATIONS

- 1.1.1. **Car** means a singular representation of a Car Model possessing a Technical Credential, entered by an Entrant in an Event.
- 1.1.2. **Car Model** means a specific model of a vehicle constructed by an IMSA-recognized Manufacturer Partner, and intended for Competition.
- 1.1.3. **Class** means a category for Cars sharing a common set of Homologation Regulations and differentiated from others by type of Car Model.
- 1.1.4. **Competition** means a contest of competitive nature in which a Car takes part during an Event and results of which Competition are published.
- 1.1.5. **Constructor** means an entity that designs and builds race car chassis.
- 1.1.6. **Entrant** means an entity or person who has entered a Car that has been accepted for Competition and holds an IMSA Membership in the capacity of an Entrant or Entrant/Driver.
- 1.1.7. **Event** means an IMSA Sanctioned motorsport activity. It includes the designated Race as well as all periods for registration, inspections, practice Sessions, qualifying Sessions, racing, pre- and post-Race activities and inspections, and rain or postponed dates related thereto.
- 1.1.8. **Homologate** means to execute the Homologation Process.
- 1.1.9. **Homologated** means a Car Model approved through the Homologation Process.
- 1.1.10. **Homologation** means the concept of all things associated with Homologation Authority approval via the Homologation Process.
- 1.1.11. **Homologation Authority** means an entity with the authority to Homologate.
- 1.1.12. **Homologation Documentation** means all files, documents, information, and communication associated with the issuance of official approval of Homologation.
- 1.1.13. **Homologation Identifier** means the unique identifier (generally including a string of characters identifying the Category or Class of Homologation followed by a sequential number assigned to the Car Model) serving as a reference to the official approval of Homologation, assigned by the Homologation Authority.
- 1.1.14. **Homologation Process** means all procedures associated with petitioning a Homologation Authority for approval that a Car Model complies with the Homologation Regulations.
- 1.1.15. **Homologation Regulations** means a set of technical requirements and criteria used to design, construct, and document a Car Model intended for racing in a specific category or class of racing.
- 1.1.16. **Manufacturer** means a Manufacturer Partner constructing an approved Car Model.
- 1.1.17. **Manufacturer Partner** means a recognized IMSA Official Automotive Partner.
- 1.1.18. **Permissive** means modifications explicitly authorized by these Technical Regulations are permitted and modifications not explicitly authorized by these Technical Regulations are prohibited.
- 1.1.19. **Specification** means all technical characteristics of the Car Model defined by the Homologation and Technical Credential.
- 1.1.20. **Specific Homologation** means the Homologation specific to a particular Car Model.
- 1.1.21. **Specific Technical Credential** means the Technical Credential specific to a particular Car Model.
- 1.1.22. **Technical Credential** means the concept of all things associated with IMSA approval via the Technical Credential Process.
- 1.1.23. **Technical Credential Documentation** means all files, documents, information, and communication associated with the Technical Credential Process.
- 1.1.24. **Technical Credential Identifier** means the unique identifier that serves as a reference to the Technical Credential granted by the IMSA. Example: IMSA GTLM 20170101 [GTE-0XX].
- 1.1.25. **Technical Credential Process** means all procedures associated with petitioning IMSA for approval that a Car Model is Technically Eligible.

- 1.1.26. **Technical Eligibility Form** means the form which documents the Specific Technical Credential.
- 1.1.27. **Technically Eligible** means conforms to all technical requirements and criteria defined by these Technical Regulations.

## ARTICLE 2. TECHNICAL PHILOSOPHY

### 2.1. Technical Eligibility

- 2.1.1. Car Models Technically Eligible for participation in IMSA Events are issued a Technical Credential Identifier.
- 2.1.2. Cars representing a Car Model must always respect the Specification.
- 2.1.3. To be issued a Technical Credential Identifier for participation in this Class, a Car Model must:
  - a. Be a Car Model constructed by an IMSA-recognized Manufacturer Partner.
  - b. Hold a valid Homologation conforming to the Homologation Regulations and Homologation Documentation specific to the Class, approved and issued by an IMSA-recognized Homologation Authority.
  - c. Successfully complete the IMSA Technical Credential Process.
- 2.1.4. IMSA is the sole authority to define the Technical Eligibility of a Car Model and issue the Technical Credential.

### 2.2. Balance of Performance Adjustment

- 2.2.1. To maintain stratification between Classes, IMSA uses the Balance of Performance process as outlined in Article 6 to mandate adjustments to the Specification.
  - a. Performance is evaluated using observed performance data; including, but not limited to, the IMSA Scrutineering data logger and official Timing and Scoring.

### 2.3. Changes

- 2.3.1. Changes to the Specification are prohibited, unless explicitly authorized by IMSA.
- 2.3.2. Manufacturers alone must petition IMSA to change the Specification; requests by Entrants are not recognized.

## ARTICLE 3. USING THESE TECHNICAL REGULATIONS

### 3.1. Structure

- 3.1.1. These Technical Regulations are structured to assist Manufacturers and Entrants in accurate interpretation of the technical expectations and enforcement of the IMSA Technical Philosophy.
  - a. A brief description of each Article and its purpose follows:

Article / Name	Description / Purpose
1. Definitions Specific to the Technical Regulations	Standardized meanings for specific terms of these Technical Regulations.
2. Technical Philosophy	Guiding principles for these Technical Regulations.
3. Using These Technical Regulations	General structure, purpose, and clarifying statements for these Technical Regulations.
4. Homologation	Pertinent topics related to Homologation.
5. Technical Eligibility	Pertinent topics related to Technical Eligibility.
6. Balance of Performance	General processes associated with competitive equivalency.
7. Safety	Regulatory requirements associated with mandatory safety systems.
8. Definition of Class	Statement of specific Class, Homologation, and Technical Eligibility requirements.
9. Series Required Electronics	Regulatory requirements associated with mandatory electronic systems.
10. Vehicle Systems	Approved modifications to the Homologation component of the Car Model Specification.
11. Refueling System	Regulatory requirements associated with specified refueling system.

### 3.2. Conflict Resolution

- 3.2.1. These IMSA Technical Regulations shall govern in any case where a conflict exists with the Homologation Regulations and Documentation.

### 3.3. Final Authority

- 3.3.1. IMSA is the Final Authority with respect to these Technical Regulations.

## ARTICLE 4. HOMOLOGATION

---

### 4.1. Homologation Regulations

- 4.1.1. Reference to the official Homologation Regulations defining the requirements applicable to these Technical Regulations is provided in ARTICLE 8. DEFINITION OF CLASS.

### 4.2. Homologation Process

- 4.2.1. The procedures of the Homologation Process are used to verify that the Car Model meets the necessary requirements and criteria defined by the official set of Homologation Regulations.
- 4.2.2. This process generally includes the following components or phases, which must be completed to the satisfaction of the Homologation Authority:
- a. Homologation Files and Documentation
  - b. Homologation Inspection
  - c. Homologation Testing
  - d. Final Approval
  - e. Identification Assignment
- 4.2.3. Homologation Process fees may apply.

### 4.3. Homologation Files and Documentation

- 4.3.1. All files and documents required by the Homologation Authority to support the Homologation Process; including but not limited to:
- a. Basic Homologation Form
  - b. Homologation Extension Form(s)
  - c. Data Sheet(s)
  - d. CAD Models and Drawings
  - e. Logged Vehicle Data
  - f. Homologation Testing Data
- 4.3.2. Basic Homologation Form: Documents how the Car Model complies with the Homologation Regulations; including photographs, drawings, descriptions, and measurements defining the characteristics, components, parameters, and/or dimensions and tolerances for:
- a. General Vehicle
  - b. Specific Vehicle Systems
  - c. System Assemblies, Parts and Components
  - d. Modifications to the Original Series Production Car (if applicable)
- 4.3.3. Homologation Extension Forms: Describe all approved modifications made to the Basic Homologation Form, including but not limited to modifications for:
- a. Correction of incorrect information
  - b. Safety reasons
  - c. Reliability reasons
  - d. Evolutions of type introduced on the original Car Model (if applicable)
  - e. Evolutions for new components and/or characteristics that cancel and replace those featured in the original Basic Homologation Form
  - f. Variant options, such as endurance packages

- 4.3.4. CAD Models and Drawings: As required by the Homologation Authority to support the Homologation Process; including but not limited to:
  - a. Complete Vehicle CAD Models
  - b. Specific Component CAD Models
  - c. Specific Component Drawings
  - d. Engine Air Intake Restrictor(s)
- 4.3.5. Homologation Testing Data: Information, documentation, data, and results from Homologation Testing.

#### 4.4. Homologation Inspection

- 4.4.1. The inspection process for drawings, CAD models, any reference component, and the constructed Car Model by the Homologation Authority.
  - a. These inspections confirm that a Car Model complies with the Homologation Regulations and are generally conducted as part of the following phases of the Homologation Process:
    - i. Design
    - ii. Construction
    - iii. Final Approval

#### 4.5. Homologation Testing

- 4.5.1. Any testing conducted by the Homologation Authority to support the Homologation Process; including, but not limited to:
  - a. Straight-line Testing
  - b. Wind Tunnel Testing
  - c. Engine Dyno Testing
  - d. Track Testing

#### 4.6. Homologation Identifier

- 4.6.1. The Homologation Identifier is electronically stamped/associated with all information, documentation and files associated with the Homologation.

#### 4.7. Conditions for Use of a Specific Homologation

- 4.7.1. At all times during IMSA-sanctioned Events it is the Entrant's responsibility to ensure the configuration of the Car Model represents the Homologation components of the Specification; including:
  - a. As-Homologated Configuration
  - b. As-Delivered Configuration
  - c. Parts Manual
  - d. Homologation Extension Form Configuration
- 4.7.2. The original, As-Homologated Configuration of the Car Model must not be modified unless permitted by these Technical Regulations.
- 4.7.3. The As-Delivered Configuration of a Car must respect the as-received configuration from the Car Model Manufacturer, unless permitted by these Technical Regulations.
- 4.7.4. The Parts Manual is the official parts catalogue for the Car Model as defined by the Car Model Manufacturer or Constructor:
  - a. Specific parts listed in the Parts Manual must be used on all representations of a Car Model unless permitted by these Technical Regulations.
- 4.7.5. To be eligible for use in any IMSA-sanctioned Event, modifications detailed in Homologation Extension Forms must:
  - a. Comply with these Technical Regulations.
  - b. Be approved by, or have initiated the process to obtain approval from, the Homologation Authority, and appended to the Car Model Homologation.
  - c. Be approved by IMSA
  - d. Be available to all Entrants of the relevant Homologated Car for the next Event.



## ARTICLE 5. TECHNICAL ELIGIBILITY

### 5.1. Technical Credential Process

- 5.1.1. Manufacturers may begin the Technical Credential Process for a Car Model provided the Car Model:
  - a. Holds, or have initiated the process to obtain approval from, a valid Homologation as defined in these Technical Regulations.
  - b. Is approved by IMSA.
- 5.1.2. The procedures of the Technical Credential Process are used to verify that the Car Model meets the necessary requirements and criteria defined by these Technical Regulations.
- 5.1.3. This process generally includes the following components or phases, which must be completed to the satisfaction of IMSA:
  - a. Technical Credential Files and Documentation
  - b. Technical Eligibility Testing
  - c. Final Approval
  - d. Identification Assignment
- 5.1.4. IMSA may request Manufacturers submit reference components to support the Technical Credential process.
  - a. IMSA may retain these components without compensation.
- 5.1.5. IMSA may request Manufacturers submit reference tooling and/or templates to support the Technical Inspection process.
- 5.1.6. Technical Credential fees may apply.

### 5.2. Technical Credential Files and Documentation

- 5.2.1. All files and documents required by IMSA to support the Technical Credential Process; including but not limited to:
  - a. Technical Eligibility Form
  - b. Data Sheet(s)
  - c. CAD Models and Drawings
  - d. Logged Vehicle Data
  - e. Electronic Controller Calibrations
  - f. Technical Eligibility Testing Data
- 5.2.2. Technical Eligibility Form: Documents how the Car Model complies these Technical Regulations; including:
  - a. List of all files and documentation associated with the Specific Homologation of the Car Model
  - b. List of all files and documentation associated with the Specific Technical Credential of the Car Model
  - c. All approved IMSA-Only Declarations
- 5.2.3. CAD Models and Drawings: As required by IMSA to support the Technical Credential Process; including but not limited to:
  - a. Complete Vehicle CAD Models
  - b. Specific Component CAD Models
  - c. Specific Component Drawings
  - d. Additional components requested by IMSA
- 5.2.4. Technical Eligibility Testing Data: Information, documentation, data, and results from Technical Eligibility Testing.

### 5.3. Technical Eligibility Testing

- 5.3.1. Any testing conducted by IMSA to support the Technical Credential Process; including, but not limited to:
  - a. Restrictor Flow
  - b. Engine Dyno
  - c. Wind Tunnel
  - d. On-track Testing
  - e. Fuel Delivery Testing
  - f. Fuel Consumption Testing

#### 5.4. Technical Credential Identifier

- 5.4.1. The Technical Credential Identifier is electronically stamped/associated with all information, documentation and files associated with the Technical Credential.

#### 5.5. Conditions for Use of Specific Technical Credential

- 5.5.1. At all times during IMSA-sanctioned Events it is the Entrant's responsibility to ensure the configuration of the Car Model represents the approved Technical Credential components of the Specification.

### ARTICLE 6. BALANCE OF PERFORMANCE

---

#### 6.1. Balance of Performance

- 6.1.1. IMSA may, at its discretion, utilize an adjustment method to maintain stratification between Classes.
- 6.1.2. All decisions by IMSA regarding Balance of Performance are Conclusive and not subject to protest or appeal.
- 6.1.3. Providing false or intentionally misleading information is a breach of these Technical Regulations.

#### 6.2. Criteria for Adjustments

- 6.2.1. Performance is evaluated using observed performance data; including, but not limited to, the IMSA Scrutineering data logger and official Timing and Scoring.
- a. IMSA may omit from consideration any data not indicative of the established performance of the Car Model.

#### 6.3. Adjustment Parameters

- 6.3.1. The following adjustments may apply:
- a. Minimum mass
- b. Engine performance
- c. Maximum fuel capacity
- d. Aerodynamic elements and/or settings
- e. Other parameters as designated by IMSA

#### 6.4. Release of Adjustments

- 6.4.1. IMSA may release Balance of Performance adjustments at any time during the season.
- 6.4.2. All adjustments take effect seven (7) days after publication except in the case of Events on consecutive weekends.

### ARTICLE 7. SAFETY

---

#### 7.1. Driver Safety Harness System

- 7.1.1. Cars must be equipped with a minimum 6-point Driver safety harness with a valid label demonstrating compliance with one of the following standards:
- a. FIA Standard 8853/98: FIA Safety Harnesses Standard
- i. [FIA Technical List #24](#): Harnesses Homologated by the FIA according to the FIA Standards 8853/98 and 8854/98
- b. FIA Standard 8853-2016: Safety Harnesses
- i. [FIA Technical List #57](#): Harnesses Homologated according to the FIA Standard 8853-2016
- c. SFI Specification 16.5: Stock Car Driver Restraint Assemblies
- i. [Specification](#)
- ii. [Manufacturers](#)
- d. SFI Specification 16.6: Advanced Motorsport Driver Restraint Assemblies
- i. [Specification](#)
- ii. [Manufacturers](#)

- 7.1.2. Installation must be performed in accordance with instructions provided by the system supplier and/or manufacturer.
  - a. Belt components must be installed at each anchor point to prevent accidental release or opening.
  - b. Individual belt straps must be independent; any method or attempt to combine individual straps is prohibited.
  - c. Elastic retention straps are prohibited on shoulder belts.
- 7.1.3. Harnesses must be replaced at the request of IMSA, or whenever the following conditions occur:
  - a. Expiration:
    - i. FIA Homologated: Immediately following December 31<sup>st</sup> of the year printed on the label.
    - ii. SFI Certified (punched/cut label): Two years from the date as stated on label. If label is not properly “cut” by the manufacturer or their representative, the date for expiration shall be January 1<sup>st</sup> of the earliest year printed on the label + two years.
    - iii. SFI Certified (non-punched label): On June 30<sup>th</sup> or December 31<sup>st</sup>: of the year identified as the date for expiration.
  - b. Damage:
    - i. Following a severe collision.
    - ii. Webbing is cut or frayed, or weakened due to actions of chemicals or sunlight.
    - iii. Buckles are bent, deformed, rusted, or improperly functioning.
- 7.1.4. Entrants are responsible for ensuring the Driver safety harnesses and all associated components are properly labeled, installed, used, and maintained.
- 7.1.5. Belt components must be used as designed by the manufacturer and tested by SFI or FIA. It is prohibited to “mix” belt components to include:
  - a. Belt components from different manufacturers.
  - b. Belt components certified by SFI and FIA.

## **7.2. Seat**

- 7.2.1. As homologated.

## **7.3. Driver Containment Nets**

- 7.3.1. Not Applicable

## **7.4. Protective Padding**

- 7.4.1. Not Applicable

## **7.5. Protective Shielding**

- 7.5.1. Cars may be equipped with shielding to protect the Driver against contact with cockpit equipment in a collision.
- 7.5.2. Installation requirements:
  - a. Installations must not impact cockpit exit.
  - b. Installations of protective shielding must use fire-resistant materials and if impact padding is used it must comply with FIA 8857-2001, SFI 45.1 or SFI 45.2.
  - c. Installations must be presented to and approved by IMSA at time of technical inspection.

## **7.6. Master Electrical Switches**

- 7.6.1. As homologated.
- 7.6.2. Systems must remain functional during any on track activity or at the request of IMSA.
- 7.6.3. Interior and exterior master switches must be clearly identified by a self-reflective symbol of a red spark surrounded by a white-edged, blue triangle with a base greater than 30 mm.

## 7.7. Fire Suppression System

- 7.7.1. Cars must be equipped with a fire extinguisher system with a valid label demonstrating compliance with one of the following standards:
  - a. FIA Standard for plumbed-in Fire Extinguisher Systems in Competition Cars (1999):
    - i. [FIA Technical List #16](#): Extinguisher Systems Homologated by the FIA
  - b. FIA Standard 8865-2015: Plumbed-in and Hand-Held Fire Extinguisher Systems
    - i. [FIA Technical List #52](#): Plumbed-in Fire Extinguisher Systems according to FIA Standard 8865-2015
- 7.7.2. Extinguishing media must be compatible with all aspects and accessories of the fire suppression system.
  - a. All system components must be used and serviced per manufacturer specifications.
- 7.7.3. System must be securely mounted.
  - a. The following must be visible without the use of photography, tools, or seat removal:
    - i. Pressure gauge (if present)
    - ii. Date of manufacture
    - iii. Next required service date
  - b. Nozzles must not point directly at the Driver's face.
- 7.7.4. System must include an exterior activation mechanism proximal to the exterior master electrical switch at (or near) the base of the left side A-Pillar.
  - a. Exterior activation mechanism must be located such that emergency responders may activate with a single action:
    - i. Using a gloved finger, or tools such as a hook.
    - ii. Unencumbered by bodywork, windscreen wipers, or any equipment that may require multiple actions.
  - b. A method for preventing activation of the exterior activation mechanism:
    - i. May be enabled when the Car is in Technical Inspection, in the Paddock, or located near large crowds, such as during pre-Race activities.
    - ii. Must be removed prior to participation in on-track activity.
- 7.7.5. Identification
  - a. Exterior activation mechanism must be marked with a self-reflective symbol with a red edge surrounding a red "E" inside a white circle at least 100 mm in diameter.
  - b. The interior fire activation switch, located in cockpit, must be marked with an appropriately sized decal of a red "E" inside a white circle.
- 7.7.6. Inspection
  - a. IMSA may require removal of the fire bottle for Technical Inspection.
  - b. Entrant is responsible to demonstrate proper system function of the interior and exterior fire suppression activation mechanisms, using the "test" mode if present.

## ARTICLE 8. DEFINITION OF CLASS

### 8.1. Le Mans Prototype 2 (LMP2)

- 8.1.1. Class Structure: Prototype Cars compete in the LMP2 Class of the IMSA WeatherTech Sportscar Championship (IWSC).
- 8.1.2. Eligibility Requirements: To be eligible for participation in the Class, a Car Model must respect the Specification defined by the Homologation and Technical Eligibility requirements:

- a. Homologation (LMP2):

<b>Homologation Authority:</b>	Federation Internationale de l'Automobile (FIA)
<b>Homologation Specification:</b>	Le Mans Prototype 2 (LMP2)
<b>LM P2 Homologation Regulations:</b>	<a href="#">2018 FIA Technical Regulations for LM P2 Prototype Homologated in 2017</a>

## ARTICLE 9. VEHICLE SYSTEMS

### 9.1. General

- 9.1.1. All Vehicle Systems and associated sub-systems are listed in this Article.
  - a. Where change to the Homologated Vehicle Systems is permitted, regulatory text is **bold and underlined**.
  - b. Where change to the Homologated Vehicle Systems is prohibited, regulatory text is light grey.
  - c. Advisory statements are in normal text.

### 9.2. Modifications to the Specification

- 9.2.1. Entrants may execute the following changes to parameters defined by the Homologation component of the Car Model Specification, provided these Technical Regulations, all current Technical Bulletins, and the Technical Credential are fully respected:
  - a. Adjust component settings defined as adjustable.
  - b. Replace components with parts defined as optional.
- 9.2.2. Manufacturers must make any declarations listed in these Technical Regulations in the Technical Eligibility Form.
- 9.2.3. Further authorization to modify the Specification and/or As-Delivered Condition is granted via the following formal communication methods:
  - a. Published IMSA Technical Bulletin
  - b. Approved updates to the IMSA Technical Eligibility Form
- 9.2.4. Informal and/or verbal communication is not considered valid authorization.

### 9.3. Servicing, Repair, and Replacement

- 9.3.1. All servicing or repair must be made in good faith to restore the Car and all components to their originally intended form and function as defined by the Specification.
- 9.3.2. Entrants may replace damaged or worn components provided these Technical Regulations are respected.

## 9.4. Dimensions

### 9.4.1. General

- a. IMSA's calibrated measurement instruments are the official measurement instruments.
- b. Scrutineering measurement(s) are taken with the applicable dry-type tire set installed.
  - i. Tire compound per the applicable Event SR.
- c. Tire pressure shall be set at 30.0 psi ( $\pm 0.5$  psi) for scrutineering measurement(s).

### 9.4.2. Reference Surface

- a. The flat floor reference surface of the Car is measured to the plane of the Technical Inspection surface plate.

### 9.4.3. Mass

- a. The minimum mass for all Car Models is defined via Balance of Performance Tables and associated Technical Bulletins.
- b. Car mass is measured as-raced minus Driver and Fuel using the IMSA scales during Technical Inspection.

### 9.4.4. Ballast

- a. **Entrants may add or remove ballast to achieve minimum mass:**
  - i. Ballast must be located per the Constructor's Base Homologation.
- b. Manufacturers and/or Constructors must place ballast in assigned locations when required by IMSA.

### 9.4.5. Ground Clearance

### 9.4.6. Overall Dimensions

- a. Length
- b. Width
- c. Height
- d. Wheelbase
- e. Track
- f. Overhang
- g. Width

## 9.5. Chassis

### 9.5.1. General

- a. **Entrants may execute minimum modifications for the installation of components.**
  - i. All modifications must be approved by IMSA.

## 9.6. Driver Interface

### 9.6.1. General

- a. **Entrants may install a driver hydration system.**
  - i. Installations must be approved by IMSA.
  - ii. System must not serve any additional purpose.

### 9.6.2. Steering Wheel

- a. **Entrants may add, and/or modify the shape of, steering wheel grips.**

### 9.6.3. Pedal Box

- a. **Entrants may apply non-slip adhesives to the surface of driver pedals.**

### 9.6.4. Shifting Mechanism

### 9.6.5. Driver Adjustable Components

### 9.6.6. Driver Cooling Systems

## 9.7. Bodywork

### 9.7.1. General

- a. All bodywork must comply to the submitted homologated CAD and geometries tested at IMSA's Windshear Test, within a tolerance of +/- 2 mm.
- b. No material may be added or removed from planks.
- c. No bodywork is permitted below the Reference Surface.
- d. **Entrants may install the following film to the front windscreen:**
  - i. Tear-offs
  - ii. Anti-fog

### 9.7.2. Bodywork Seams

- a. **Entrants may apply tape over the body seams around refueling receptacles.**

### 9.7.3. Decals

- a. **Entrants may apply removable die cut sponsorship decals with the approval of IMSA.**

## 9.8. Aerodynamic Elements

### 9.8.1. General

- a. All aerodynamic elements must comply to the submitted homologated CAD and geometries tested at IMSA's Windshear Test, within a tolerance of +/- 2 mm.
- b. No aerodynamic element is permitted below the Reference Surface.

### 9.8.2. Splitter

- a. As per Technical Bulletin.
- b. The lowest points on the splitter must be coplanar with the Reference Surface within a tolerance of +2 mm / -0 mm.

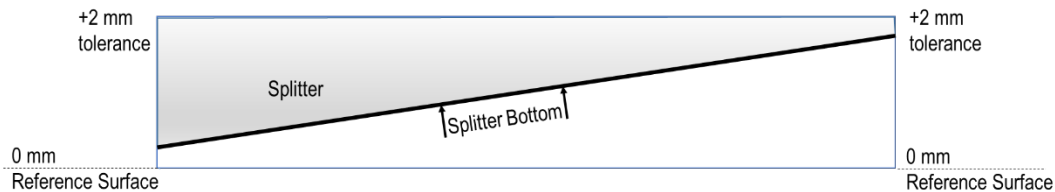

### 9.8.3. Dive Planes

- a. As per Technical Bulletin.

### 9.8.4. Body Gurney

- a. As per Technical Bulletin.

### 9.8.5. Wings

- a. As per Technical Bulletin

### 9.8.6. Rear Wing Gurney

- a. As per Technical Bulletin

### 9.8.7. Floor

### 9.8.8. Friction Blocks

### 9.8.9. Diffuser

## 9.9. Engine System

### 9.9.1. General

- a. Manufacturer seals must be respected

### 9.9.2. Engine

### 9.9.3. Lambda

### 9.9.4. Engine RPM

- a. The maximum engine RPM limits for all Car Models are defined via Balance of Performance Tables and associated Technical Bulletins.
- b. The RPM limit is considered exceeded when either of these conditions occur:
  - i. Engine RPM exceeds RPM limit for more than 250 ms, and actual pedal position is greater than 60% of the maximum
  - ii. Engine RPM is more than 1.0% over RPM limit for more than 100 ms, and actual pedal position is greater than 60% of the maximum, i.e. an 8000 RPM limit is exceeded when RPM is greater than 8080 for more than 100 ms while actual pedal position is greater than 60%.

### 9.9.5. Intake

### 9.9.6. Exhaust

### 9.9.7. Turbo

### 9.9.8. Engine Control Unit (ECU)

### 9.9.9. Engine Transportation Crate

## 9.10. Boost Management

### 9.10.1. Maximum Boost Pressure

### 9.10.2. Boost Pressure Ratio

### 9.10.3. Boost Control Strategy Inputs

### 9.10.4. Calculation Method

### 9.10.5. Low Overboost Counter Usage Limitation

## 9.11. Drive System

### 9.11.1. General

- a. Manufacturer seals must be respected

### 9.11.2. Fluids & Lubricants

- a. **Unrestricted.**

### 9.11.3. Clutch

### 9.11.4. Gearbox

### 9.11.5. Gears

- a. Entrant must utilize the Constructor's homologated Le Mans Gears

### 9.11.6. Gearbox Control Unit

### 9.11.7. Differential

### 9.11.8. Axles

### 9.11.9. Uprights



## 9.12. Cooling System

### 9.12.1. General

### 9.12.2. Fluids

- a. **Entrants may utilize non-glycol based fluids.**

### 9.12.3. Inlet Blockers

- a. **Entrants may utilize the following methods for the sole purpose of blocking off portions of the cooling system inlet openings:**

- i. Opaque adhesive tape.
- ii. Panels made from carbon fiber and/or aluminum with associated fastener hardware.

### 9.12.4. Water System

### 9.12.5. Oil Cooling System

## 9.13. Fuel System

### 9.13.1. General

- a. Maximum Capacity

- i. The maximum fuel capacity for all Car Models is defined via Balance of Performance Tables and associated Technical Bulletins.
- ii. The maximum fuel capacity is the total volume of fuel contained in the Car.

### 9.13.2. Fuel Types

- a. The approved fuel for the Class is IMSA E20C, as supplied by VP Fuels.
  - i. IMSA may require a fuel sample for inspection via a gas chromatograph

### 9.13.3. Fuel Cell

- a. **Entrants may use blocks or balls to achieve maximum fuel cell capacity:**

- i. Any device, system, or procedure designed to increase, even temporarily, the total fuel storage capacity beyond the maximum is prohibited.
- b. Any configuration of the homologated design intended to decrease the minimum refueling time below the minimum time listed in the class specific BoP table is prohibited.

### 9.13.4. Fuel Lines

### 9.13.5. Fuel Sample Port

- a. **Entrants must equip the Car with the approved self-sealing connector for extraction of fuel samples:**

- i. Approved Connector: Staubli P/N: CBI06.7251/IA/JKV.
- ii. Must be located immediately before the injector nozzles.
- iii. Installation must be approved by IMSA.

### 9.13.6. Refueling Receptacle

## 9.14. Brake System

### 9.14.1. General

### 9.14.2. Fluids & Lubricants

- a. **Unrestricted.**

### 9.14.3. Bias Assembly

### 9.14.4. Master Cylinders

### 9.14.5. Brake Lines

9.14.6. Calipers

9.14.7. Rotors

9.14.8. Pads

9.14.9. Ducting

9.14.10. Brake Duct Inlet Blockers

a. **Entrants may utilize the following methods for the sole purpose of blocking off portions of the brake duct inlet openings:**

- i. Opaque adhesive tape.
- ii. Panels made from carbon fiber and/or aluminum with associated fastener hardware.
- iii. Must be fixed.

9.14.11. Anti-Lock Braking System

## 9.15. Steering System

9.15.1. General

9.15.2. Fluids & Lubricants

a. **Unrestricted.**

## 9.16. Suspension System

9.16.1. General

9.16.2. Geometry Elements

9.16.3. Springs

a. **Entrants may change primary spring rates:**

- i. The As-delivered number of springs per wheel must be respected.

b. **Entrants may install thrust bearings between the spring and perch.**

- i. **Maximum of two (2) per spring.**

9.16.4. Dampers

a. **Entrants may change the damper internal build:**

- i. Inerter technology is prohibited.

9.16.5. Bump Rubbers and Packers

a. **Unrestricted.**

9.16.6. Anti-Roll Bar

9.16.7. Third Elements

a. **Entrants may change third element spring rates:**

- i. The As-delivered number of springs must be respected.

## 9.17. Wheels & Tires

9.17.1. General

9.17.2. Wheels

9.17.3. Wheel Attachment

9.17.4. Tires

- a. The approved tire supplier for this Class is Michelin.
- b. Tires must be used in accordance with SSR Attachment 3.

## 9.18. Electronics

9.18.1. General

9.18.2. Data Logger

- a. IMSA reserves the right to download and/or view all logged data at any time.

9.18.3. Telemetry

- a. **Entrants may utilize one-way telemetry systems for data acquisition purposes.**

9.18.4. Wiring Loom

9.18.5. Sensors

9.18.6. Radio

- a. **Entrants may install one (1) primary, and one (1) secondary, two-way voice communication radio with car-to-pit communication capability:**
  - i. Radio(s) must comply with Series Sporting Regulations.
  - ii. Secondary radio must not transmit or receive signals while primary radio is functional.

9.18.7. Rear View Camera

## ARTICLE 10. SERIES REQUIRED ELECTRONICS

### 10.1. Series Scrutineering Data System

10.1.1. Cars may be equipped with the IMSA Scrutineering Data System at all Events.

10.1.2. Cars using the IMSA Scrutineering Logger must abide by these Technical Regulations as follow.

- a. The manual for the Scrutineering Data System for the Class is the Bosch Scrutineering Systems Manual (BSSM), available on the IMSA Competitor site:
  - i. Bosch Scrutineering System Manual version ~~4.2.5.~~ 1.2.6.
- b. Scrutineering system components must be purchased from, or supplied by, the approved sources listed in the BSSM.

10.1.3. The system consists of a combination of the following as specified by IMSA:

Part Number	Item
F02U.V0U.249-01	Bosch DDU9
F02U.V0U.252-01	Bosch PBX90 PowerBox
F02U.B00.435-01	Bosch MM5.10 5-axis Inertial Measurement Unit
F02U.V0U.203-01	GPS Unit
F02U.V0U.264-01	Pitot Tube
F02U.V01.342-01	USB Stick
F02U.002.996-01	USB Data Storage Device Port
AS112-35SM	MSA Diagnostic/Communication Port
RG.DV.PV0099	Leader Light System
Provided by IMSA	X2 Transponder
Provided by IMSA	Delphi Yellow Light System
Bosch Approved Supplier	Wiring Loom

10.1.4. All components of the Scrutineering System must remain powered during on-track sessions, and pit stops.

- a. LMP2 Cars may be assigned fuel flow sensors from IMSA on a per Event basis

- 10.1.5. Entrants must complete a ~~IMSA Scrutineering Sensor Declaration Form~~ [IMSA Scrutineering Sensor Declaration Form](#) no later than 24 hours before load-in day of every Event.
- 10.1.6. Scrutineering system components and sensors must be installed per the Car Model's Scrutineering Homologation document.
- a. IMU unit must be:
- Aligned within 1 degree of centerline of Car.
  - Aligned within 0.5 degrees of horizontal.
- b. All other antennas on Car must be installed at least 250 mm from IMSA GPS Receiver.
- c. Wiring loom must be:
- Consistent with IMSA approved Car Models Scrutineering Homologation document
  - Provided by the Entrant.
  - Independent of any other system.
  - Removable.
  - Verified and serialized before Entrant participates in their first event of each season, per the Loom Certification outlined in the BSSM.
  - Certifications are only valid for the season they are issued.
  - Available for additional testing when requested by IMSA.
- 10.1.7. CAN channels must be configured per the applicable DBC file posted in the regulation section of competitors.imsa.com.
- a. Entrants must provide CAN channels from the ECU, chassis logger, or equivalent device per the CAN specification detailed in the BSSM.
- b. CAN communication to the IMSA Scrutineering Logger must be transmitted directly from the device of origin, and not repeated through a 3<sup>rd</sup> party device.
- Example: Engine RPM must be transmitted directly from the ECU to the IMSA Scrutineering Logger, and not through the chassis logger.
- c. Scrutineering sensors take precedence over CAN provided values from the ECU or chassis logger.
- d. Scrutineering sensor outputs are provided to the Entrant over a Public CAN bus.
- 10.1.8. Any repair to the looms must be approved by Bosch Motorsport and re-certification through Bosch Motorsport may be required.
- 10.1.9. Scrutineering system primary component units must have an IMSA Scrutineering Seal.
- a. Each device ordered through Bosch Motorsport NA using the order form found in the Scrutineering System Manual will be delivered with the seal in place.

## 10.2. Safety Light System

- 10.2.1. Cars must be equipped with the Delphi Yellow Light Kit to indicate active flag status.
- IMSA Scrutineering Logger equipped cars only require an Antenna Kit
  - Cars without a IMSA Scrutineering Logger require a Full Yellow Light Kit:
    - Yellow Indicator Light
    - Mounting Bracket
    - Antenna
    - Wiring Loom and Instruction
  -
- 10.2.2. The Safety Light system must be installed and functioning during on-track activity.
- a. The Yellow Indicator Light must be prominently installed within the cockpit, in clear line of sight of the driver.
- b. Antenna Installation: The supplied antenna must be mounted:
- On the Car roof
  - Away from other antennae
  - Following the diagram below (a ground plane is not required):

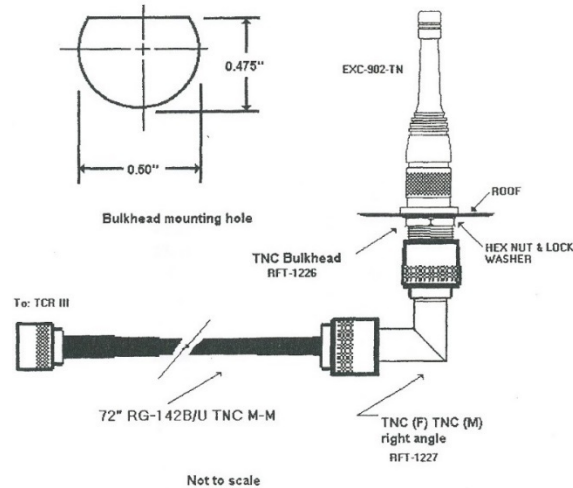

- c. Yellow Light Wiring Loom Installation for cars without IMSA Scrutineering Logger: The Wiring Loom has a flying lead input for +12 VDC and Ground to interface with additional wiring referenced in the installation instructions.

- i. Entrants must supply additional wiring as required.

10.2.3. An activating receiver is available from IMSA during Safety Checks at each Event and remains the property of IMSA.

- a. Entrants must surrender the receiver when required by IMSA.
- b. A lost or damaged receiver is subject to a replacement fee referenced in the IMSA Accessories form.
- c. Activating receiver must be installed using supplied Mounting Bracket

### 10.3. Driver ID System

10.3.1. Cars must be equipped with a Driver ID system to identify the active Driver piloting the Car.

10.3.2. Driver ID plugs must be installed and connected per:

- a. The BSSM for cars utilizing the IMSA Scrutineering Logger
- b. The applicable Declaration Form for car not utilizing the IMSA Scrutineering Logger is contained within the Leader Light Kit in Article 10.5.2.

10.3.3. Transponder and plugs must be tested and operate to the satisfaction of the Timing and Scoring Officials.

### 10.4. X2 Transponder System

10.4.1. Cars must be equipped with the X2 Transponder System Kit to transmit scrutineering data from the car

- a. X2 Transponder Kit contains the following component(s):
  - i. Transponder.
  - ii. Isolation Mounts.

10.4.2. X2 transponder may be purchased via the IMSA Accessories Order Form.

10.4.3. X2 transponder is provided by IMSA during Safety Checks at each Event, and:

- a. Remains the property of IMSA
- b. Entrants must surrender the transponder when required by IMSA
- c. Entrants is responsible for replacing a lost or damaged X2 transponder, per the IMSA Accessories Order Form.

10.4.4. For Cars utilizing the IMSA Scrutineering Logger System, the transponder system must be installed, as per Car Model's Scrutineering Homologation documentation, and functioning during Events.

- 10.4.5. Cars NOT utilizing the IMSA Scrutineering System, the transponder must be installed in the same location as the applicable Constructor has determined in the Scrutineering Homologation Document.
- 10.4.6. Transponder must be mounted using the mounting bracket with appropriate thermal protection in an area where the temperature cannot exceed 50 °C

### 10.5. Leader Light System

- 10.5.1. Cars must be equipped with LED leader light panels.
  - a. IMSA Leader Lights for cars utilizing the IMSA Scrutineering Logger System are available from Motec USA ( [https://www.milspecwiring.com/IMSA-WeatherTech-Leader-Light-Panel\\_p\\_2255.html](https://www.milspecwiring.com/IMSA-WeatherTech-Leader-Light-Panel_p_2255.html) )
    - i. Leader lights must be installed and connected to the Scrutineering System loom per the Car Model's Scrutineering Homologation document
- 10.5.2. IMSA Leader Lights for cars NOT utilizing the IMSA Scrutineering Logger System are available from Motec USA as follow:
  - a.

Constructor	Leader Light Kit Part Number
Oreca	RG.DV.PV0193
Multimatic	RG.DV.PV0194
Dallara	TBD
Ligier	TBD

- 10.5.3. Leader light system must be installed and functioning during Events.

### 10.6. Back-lit Panel

- 10.6.1. Cars must be equipped with white light-emitting side number panels for Races taking place partly by night.
  - a. Colored background must be cut out in the number shapes so they are illuminated during the night.
  - b. White light-emitting side number panels are supplied by Entrants.

### 10.7. Pro-Am Light

- 10.7.1. Cars must be equipped with a Pro-Am light per the Car Model's Scrutineering Homologation document.
- 10.7.2. Pro Am light must be powered on at all times when the car is participating in on-track activity.

### 10.8. Rain Light

- 10.8.1. Cars must be equipped with a Rain Light system controlled by the Entrant.
  - i. Entrants are required to turn the system on or off, change the brightness, and/or flashing frequency of the Rain Lights upon request from IMSA.

### 10.9. In-Car Camera

Not Applicable

## ARTICLE 11. REFUELING SYSTEM

### 11.1. Fuel Transfer

- 11.1.1. Fuel may be transferred from the autonomous supply tank to the Car using the equipment and methods defined in this Article.
- a. Approved equipment as defined herein must be:
    - i. Unmodified.
    - ii. Installed and operational.
  - b. Approved method:
    - i. Gravity.
- 11.1.2. Fuel transferred to the autonomous supply tank must be delivered by means of a hose fitted with a self-sealing connector (e.g. dry break, cam-lock) connected to the autonomous supply tank.

### 11.2. Pit Tank

- 11.2.1. Construction of the Autonomous Supply Tank must:
- a. Comply with FIA Appendix J Drawing n° 252-7 with the exception of the top plate shape and dimensions.
  - b. Any configuration of the IMSA-mandated design intended to decrease the minimum refueling time below the minimum time listed in the class specific BoP table is prohibited.
  - c. Have a simple cylindrical internal shape.
  - d. Not have any additional internal parts that could improve flow.
  - e. Have a tolerance on bottom flatness of less than 3 mm inside the tank.
  - f. Have the flow restrictor top face at the level of the internal surface of the bottom of the supply tank.
  - g. Have provisions to seal any mechanisms that regulate tank height.
- 11.2.2. Pit tanks are assigned a serial number by IMSA Technical Officials.
- a. IMSA Technical Officials will apply a non-removable official technical inspection serial number label to pit tanks
- 11.2.3. Refueling tank height is measured from the top surface of the vessel, not including vent, cover, cover plate, or fasteners, at a distance of 1.25 meters from the outermost face of the pit wall
- a. The required refueling tank height is 2.0 meters with a tolerance of +0/-1.0 cm.
- 11.2.4. Once inspected by an IMSA Official the Autonomous Supply Tank, Trolley, Peripheral Connections, and Restrictor must remain as inspected with all IMSA seals intact until the conclusion of the Race or upon an approved retirement via TIMS.

### 11.3. Peripheral Connections

- 11.3.1. Tanks must be equipped with the IMSA-specified peripheral connections between the tank outlet and the refueling hose.
- a. Parts must be purchased from RPXpress (Phone: +1-828-428-0820 Email: [Imcelwain@rpxpress.com](mailto:Imcelwain@rpxpress.com)) and used unmodified:

Part Number	Part	Description
BSR-FR FN40	Outlet Flange	Bottom Tank 12-bolt housing
ATL-TF 147	12-Bolt Gasket	
BSR.FR.R.35GOLD	35.0mm Restrictor	Upper Restrictor (for positive seal to Elbow)
BSR-FR 1981	Bottom 80 deg. Elbow	Female Camlock x 2" Male
BSR-FR R003	Deadman Valve	Stainless Deadman Valve
BSR.P.5K56.SS	Restrictor Housing	Deadman Outlet, 2" Male to 1 ½" Camlock

- b. FIA nut ring, as-supplied with original tank, must be used to secure the restrictor housing to the bottom of the supply tank.

- c. A 0.125 inch hole must be drilled in two adjacent bolts connecting restrictor housing and FIA nut ring.
- d. Refueling System Assembly Illustration:

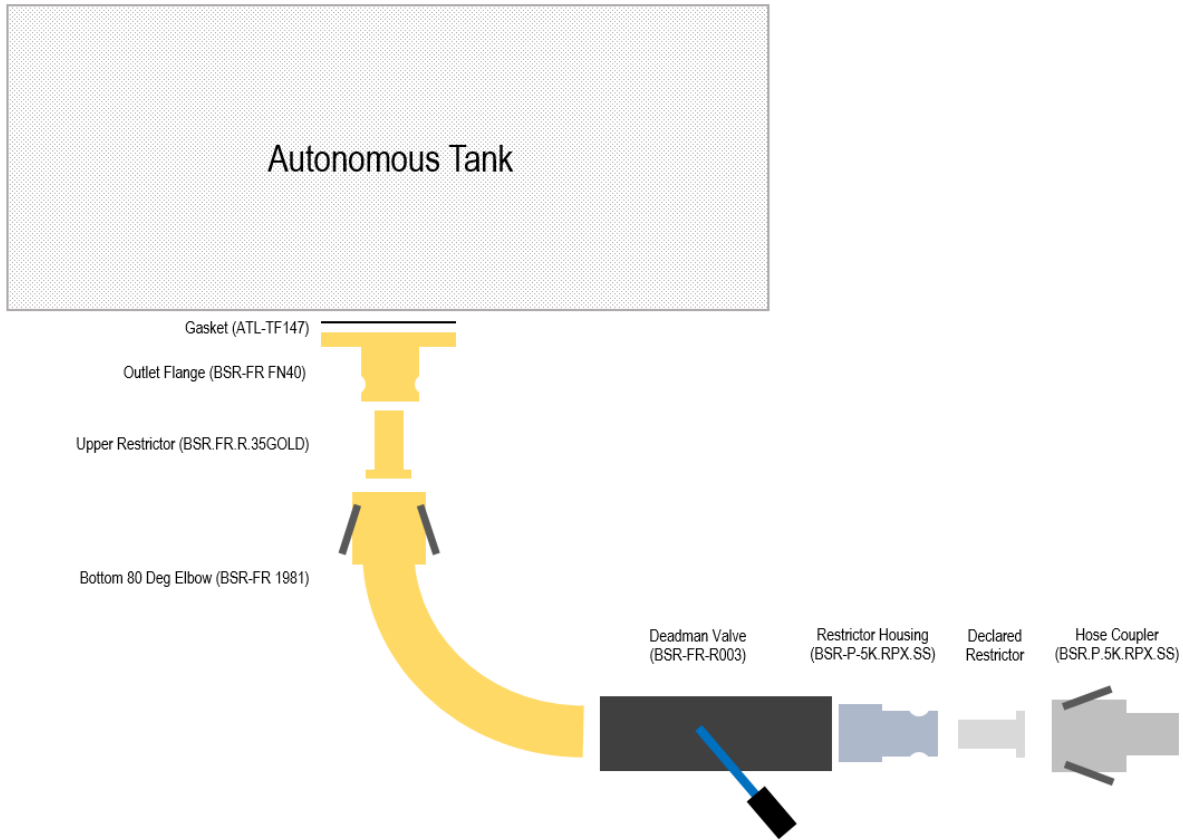

- 11.3.2. Deadman valve and bottom 80 deg. elbow assembly must be securely braced to remain attached to the tank in the event of an incident.
  - a. Mechanisms preventing normal operation of the deadman valve are prohibited.
  - b. Any configuration of the IMSA-mandated design intended to decrease the minimum refueling time below the minimum time listed in the class specific BoP table is prohibited.
  - c. During fuel delivery operations, the deadman valve must be fully open such that the throat of the ball is aligned axially with the outlet of the deadman valve body with the actuation handle fully extended.
    - i. Adjustment mechanisms will be sealed by IMSA.
- 11.3.3. During refueling the air vent outlet must be connected using an appropriate coupling to the tank.
  - a. In dual point refueling, the dedicated vent hose maximum inside diameter must be less than 1.5 inches.
- 11.3.4. A sight glass may be installed to the outside of the supply tank and must be equipped with isolating valves mounted as close as possible to the tank.

#### 11.4. Refueling/Vent Hoses

- 11.4.1. Refueling/vent hoses must have one end equipped with a self-sealing connector to fit the autonomous supply tank outlet.
- 11.4.2. Refueling/vent hoses may be protected for the sole purpose of resisting abrasion damage.
  - a. Cover must be easily removable by means of full-length Velcro or zipper.
  - b. Cover must be non-reflective



11.4.3. Hose maximum inside diameter:

- a. Dual-port systems must be less than 1.5 inches for all hoses.
- b. Single-port (coaxial) systems must be less than 1.5 inches for Refueling Hose and less than 75.0mm for Vent Hose.

11.4.4. Refueling hose minimum length must be greater than 3.0 meters.

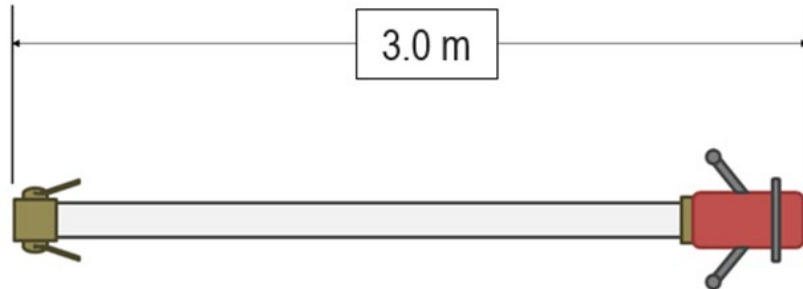

- a. Minimum length is measured from the most distant plane of the dry break/fuel probe to the most distant plane of the fuel hose coupler.
- b. Cars employing an approved offside refueling system, must have a vent hose with a minimum length of six (6) meters, connectors included.

**11.5. Pit Tank Support Stand**

11.5.1. The tank must be attached to one of the following:

- a. Through a tower, to a trolley meeting the following requirements:
  - i. All tower components must be assembled without any degree of freedom in relation to the trolley.
  - ii. Have a surface area greater than two (2) square meters.
  - iii. Utilize four (4) self-braking casters.
  - iv. Be ballasted with weight exceeding that of the tank when filled with fuel.
- b. Scissor style (X-brace) stand

**11.6. Boom**

11.6.1. Entrants may attach a member (boom) to the trolley.

- a. Boom must be independent of the tank and the tower.
  - i. Boom member must be permitted a degree of freedom in relation to the trolley (rotation following a vertical axis).
- b. Boom may support:
  - i. Hose for a Car utilizing an approved offset vent or fuel filler.
  - ii. Lighting for the illumination of the pit stop.
  - iii. Download cable.

11.6.2. Boom must be identified with the Car number fixed to its outboard end, that must be:

- a. Visible from either direction
- b. A minimum of seven (7) inches high with a 1.25-inch stroke

11.6.3. Boom must respect the following dimensions:

- a. Must not exceed four (4) meters in length
- b. Must permit free passage of a height of two (2) meters over its entire length including hoses and/or accessories.

### 11.7. Refueling Restrictor

- 11.7.1. During refueling, all fuel entering the Car must pass through the refueling restrictor.
- 11.7.2. Refueling Restrictor must meet the following criteria:
  - a. Material must be an aluminum alloy.
  - b. Must comply with the IMSA Fuel Restrictor Part Drawing at the end of these Technical Regulations.
  - c. Restrictor size varies from 22.0 mm to 34.0 mm by discrete increments 0.25 mm
  - d. Bore tolerance (+0.00 mm / -0.05 mm)
- 11.7.3. IMSA may adjust the refueling rig height and the minimum refueling time listed in the class specific BoP Tables and associated Technical Bulletins.
  - a. Refueling restrictors may be purchased from RPXpress (Phone: +1-828-428-0820 Email: lmcclwain@rpxpress.com).
  - b. At each Event, every Entrant must declare their chosen diameter, limited to 22 to 34 mm in 0.25 mm increments, by completing the ~~IMSA Refueling Restrictor Declaration Form~~ [IMSA Refueling Restrictor Declaration Form](#) prior to 5:00 PM Local Time the day before race day.
  - c. IMSA utilizes the following scrutineering inspection methods to check minimum refueling times:
    - i. Calibrated autonomous fuel supply tank level sensor system.
    - ii. Calibrated vehicle fuel flow sensors.
    - iii. Minimum Refueling Time Audit (Reference: SRR 37.6).
- 11.7.4. Refueling Restrictors are sealed by IMSA Technical Officials.
  - a. Entrants must receive written approval from IMSA to remove seals following inspection, and seals must be replaced by IMSA Technical Officials prior to on-track activity.
  - b. The following items must be drilled for safety-wire sealing of the restrictor
    - i. Two (2) adjacent Bolt heads of the Restrictor Housing
    - ii. Two (2) Hinge Bolts (threaded section) of the Outlet Pipe Cam Lock
    - iii. Two (2) Lock Lever Arms of the Refueling Hose Cam Lock
    - iv. A 0.125 inch hole must be drilled in the two female camlock levers on the bottom 80 deg. elbow assembly 0.5 inches below pin in the locations indicated in yellow on the diagram below:



### 11.8. Level Sensor System

- 11.8.1. Autonomous fuel supply tanks must be equipped with an IMSA Level Sensor Kit and wiring loom.
- 11.8.2. The level sensor kit and wiring loom are available for purchase from IMSA, and are listed on the IMSA Accessories Order Form.
  - a. Level sensor kits include:
    - i. Sensor Package
    - ii. Gasket
    - iii. Nut Plate
    - iv. All other hardware required to install the sensor in the tank
  - b. Replacement parts are listed on the IMSA Accessories Order Form.

- 11.8.3. Sensor package consists of the following sensors integrated into a single housing:
- a. Capacitive fluid level sensor
  - b. Fuel temperature sensor
  - c. Vent pressure sensor
- 11.8.4. Sensors packages are serialized, and assigned to a Car and Pit Tank.
- a. Sensors packages are calibrated to the assigned Pit Tank.
    - i. Calibrations require a drum of fuel, 2 crew members, and standard refueling safety equipment, as per Sporting Regulations 21.2.1
    - ii. Sensor package must remain exclusive to the assigned Car and Pit Tank.
  - b. Sensor packages are sealed by IMSA Technical Officials.
    - i. Entrants must receive written approval from IMSA to remove seals following calibration, and seals must be replaced by IMSA Technical Officials prior to on-track activity.
    - ii. Recalibration of sensor and tank may be required before Race.
- 11.8.5. Wiring loom connects the sensor package to a dedicated port on the IMSA pit-lane network box.
- a. Wiring loom must be IMSA certified and unmodified.
- 11.8.6. Entrant must ensure the level sensor system is functional.
- a. Two hours before 1<sup>st</sup> Practice Entrant must connect the loom to a specific pit-lane network box designated by IMSA.
  - b. Loom must remain connected until the conclusion of the Event
  - c. Entrant must remove the loom at the conclusion of the Event.
- 11.8.7. Sensor packages must be installed in the location and orientation as indicated in the following diagrams.
- a. Drilling templates and other dimensioned drawings that will assist in the modification of the tanks to accommodate the sensor installation are also included.

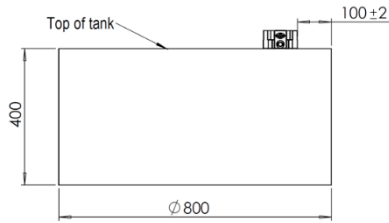
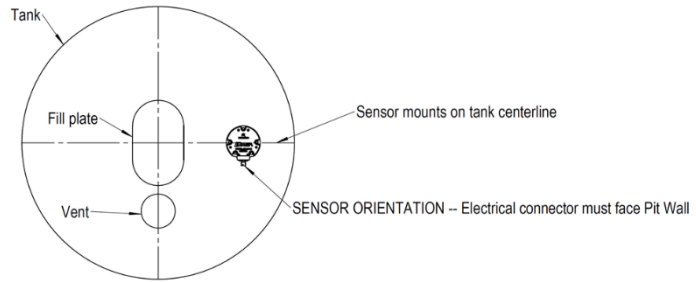
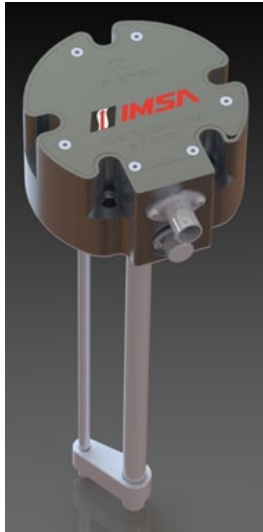

REV	DATE	DESCRIPTION	BY	APPROVED
01	27.10.15	FIRST RELEASE		NIM
02	07.11.15	NEW PROFILE		NIM
03	14.11.15	PRODUCTION RELEASE		NIM

DESIGNER:	DATE:	DRIVER AND TEST DRIVER:	FILE:
DRAWN:	27.10.15		MOUNTING BOSS DRILLING TEMPLATE
CHECKED:			
APPROVED:			
MFC:			
QA:			

WEATHERTECH 10000 WOODBRIDGE DRIVE FARMINGTON, CT 06030 USA	N/A	DMC NO.: EC-012-03 SCALE: 1:1 SHEET 011
--	-----	---

